

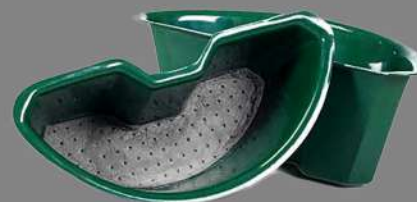

Selbstbewässernde
**hängende
Töpfe und
Blumenkästen**

TerraFlor
die Schönheit der reinen Form





BEST	2
BEST CUP	4
BARIST	6
BARIST BASE	8
CESAR	10
WOVEN	12

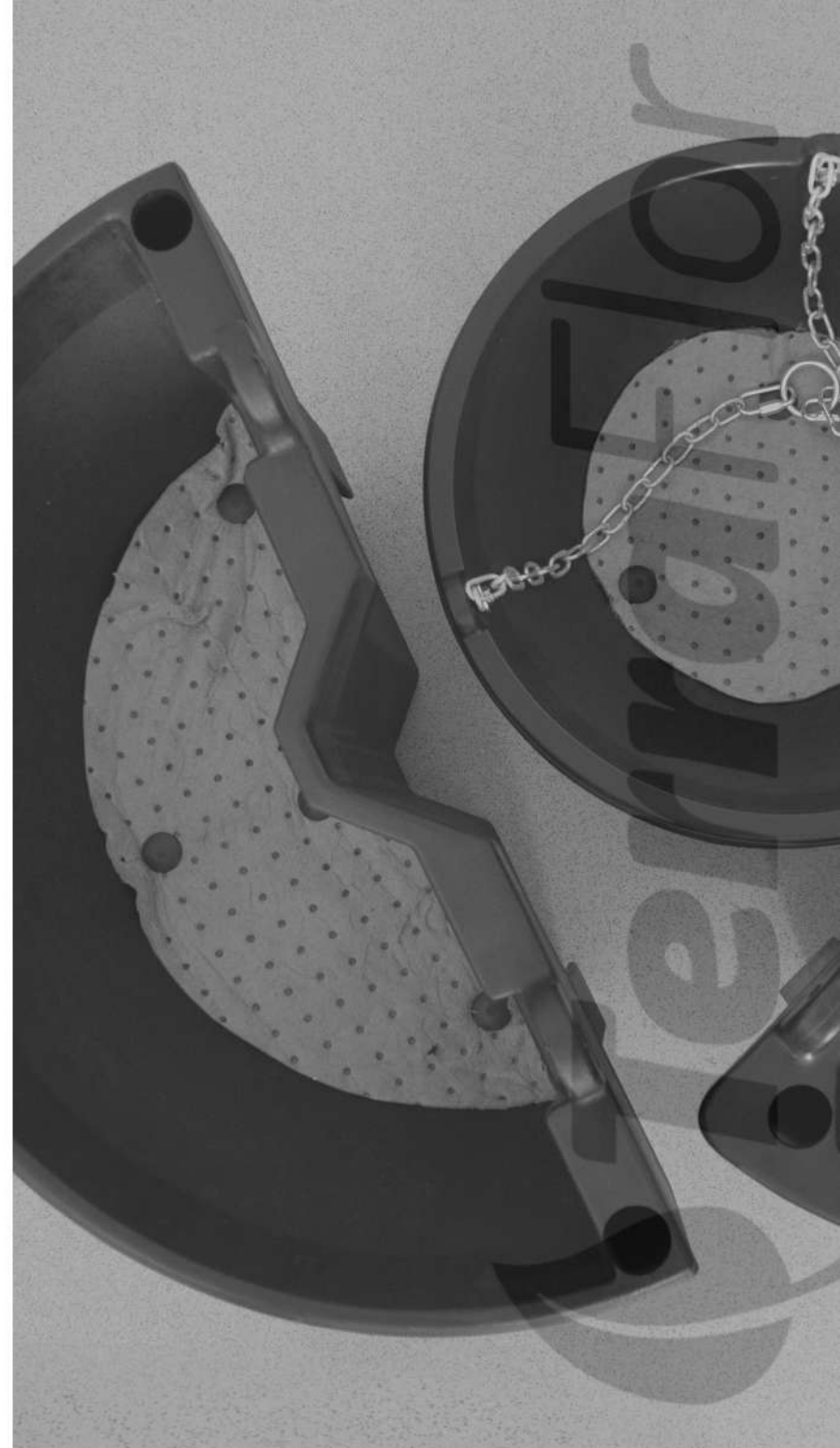



BEST



MODELL	CODE	DIMENSIONEN[MM]	PREIS
BEST Set (2 Hälften + Befestigung)	AB UTP-1P	590mm x 270mm	195 euro
Einsatz x2			90 euro
BEST Set (2 Hälften + Befestigung)	AB UTP-2P	800mm x 270mm	290 euro
Einsatz x2			110 euro

Schwarz



RAL 9005

Dunkelgrün



RAL 6032

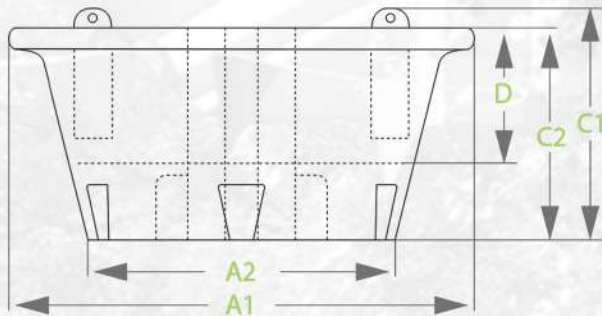
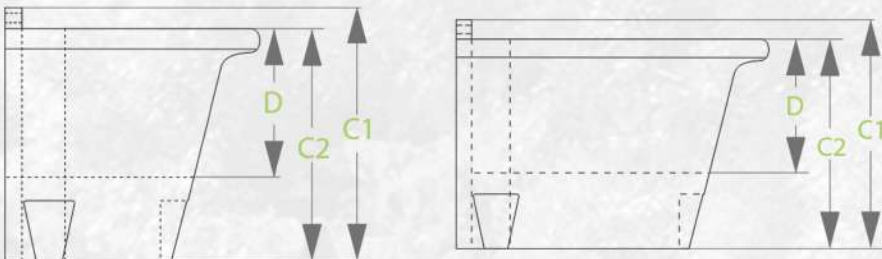

10 Jahre Garantie

BEST**TECHNIKBLATT****AB UTP-1P****VORDERANSICHT****SEITENANSICHT**

A1	Ebenenbreite	590 mm		Substratvolumen	▶	12 l
A2	Bodenbreite	390 mm		Doppelbodenvolumen	▶	5 l
B	Ebenentiefe	295 mm		Gewicht vor Bepflanzung	▶	2,2 kg
C1	Gesamthöhe	295 mm		Gewicht nach Bepflanzung	▶	14 kg
C2	Topfhöhe	270 mm		Anzahl der Setzlinge	▶	5-7 Anzahl der Setzlinge
D	Einsattiefe	170 mm				
E	Durchmesser der Unterseite des Einsatzes	410 mm				

Gewicht hängt von der Art und der Feuchtigkeit des Bodens ab

AB UTP-2P

A1	Ebenenbreite	800 mm		Substratvolumen	▶	25 l
A2	Bodenbreite	600 mm		Doppelbodenvolumen	▶	14 l
B	Ebenentiefe	400 mm		Gewicht vor Bepflanzung	▶	3,7 kg
C1	Gesamthöhe	295 mm		Gewicht nach Bepflanzung	▶	31 kg
C2	Topfhöhe	270 mm		Anzahl der Setzlinge	▶	10-12 Anzahl der Setzlinge
D	Einsattiefe	170 mm				
E	Durchmesser der Unterseite des Einsatzes	630 mm				

Gewicht hängt von der Art und der Feuchtigkeit des Bodens ab

Garantie 10 Jahre

**BEST
CUP**



MODELL	CODE	DIMENSIONEN[MM]	PREIS
BEST CUP Set (2 Hälften + Befestigung)	AB CNS-1P	650mm x 300mm	215 euro
Einsatz x2			100 euro

Schwarz

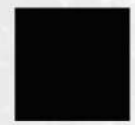

RAL 9005

Dunkelgrün



RAL 6032



10 Jahre Garantie

BEST
CUP

TECHNIKBLATT

AB CNS-1P

VORDERANSICHT

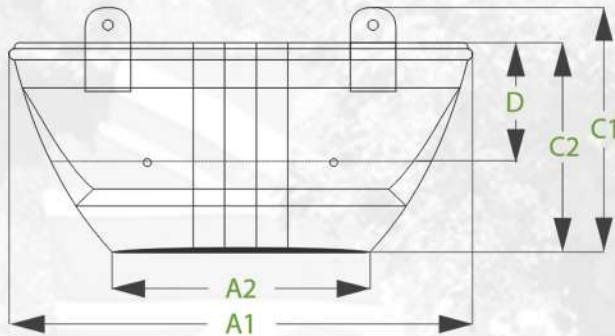

OBENANSICHT

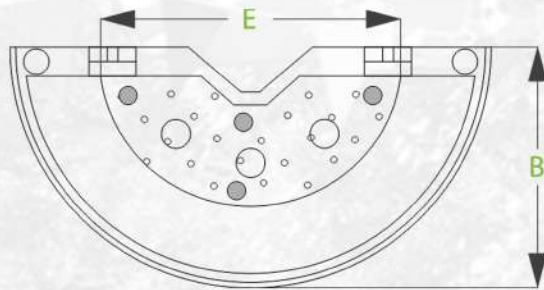

SEITENANSICHT

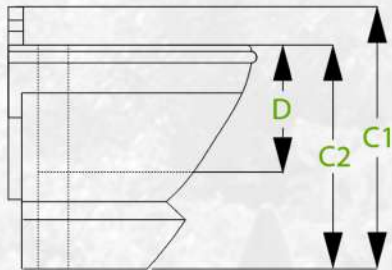

OBENANSICHT

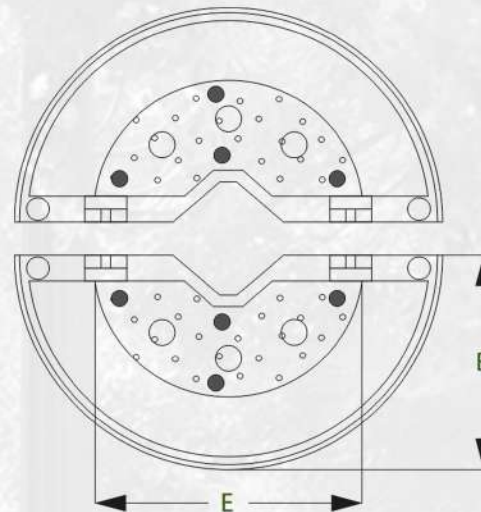

MONTAGE

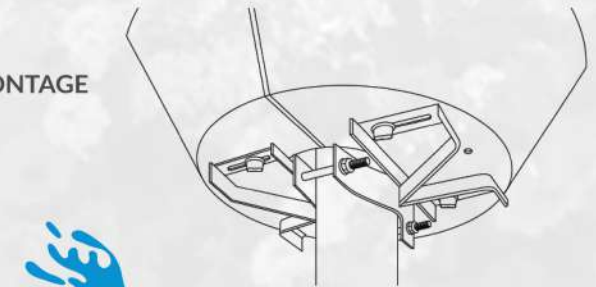

ABFLUSS

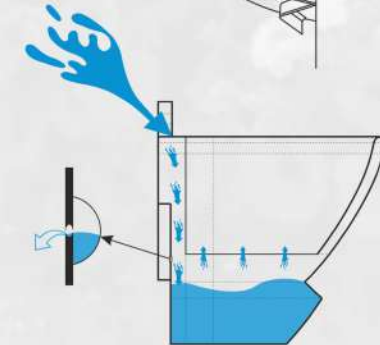

A1	Ebenenbreite	650 mm	☼	Substratvolumen	▶	12 l
A2	Bodenbreite	370 mm	💧	Doppelbodenvolumen	▶	9 l
B	Ebentiefe	325 mm	⚖️	Gewicht vor Bepflanzung	▶	2,7 kg
C1	Gesamthöhe	350 mm	⚖️	Gewicht nach Bepflanzung	▶	18 kg ?
C2	Topfhöhe	300 mm	🍷	Anzahl der Setzlinge	▶	5-7 Anzahl der Setzlinge
D	Einsattiefe	170 mm				
E	Durchmesser der Unterseite des Einsatzes	430 mm				

? Gewicht hängt von der Art und der Feuchtigkeit des Bodens ab

 **Garantie 10 Jahre**



BARIST



MODELL	CODE	DIMENSIONEN[MM]	PREIS
BARIST	AB CHB-1P	470mm x 270mm	95 euro

Schwarz



RAL 9005

Dunkelgrün



RAL 6032



10 Jahre Garantie

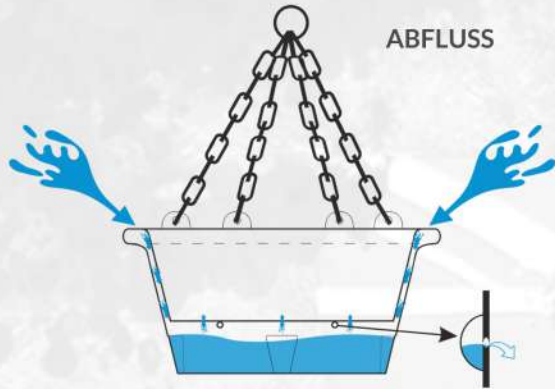

- A** Ebenendurchmesser **470 mm**
- B** Bodendurchmesser **285 mm**
- C** Gesamthöhe **270 mm**
- D** Einsattiefe **190 mm**
- E** Durchmesser der Unterseite des Einsatzes **290 mm**

-  Substratvolumen ▶ **24 l**
-  Doppelbodenvolumen ▶ **13 l**
-  Gewicht vor Bepflanzung ▶ **3,7 kg**
-  Gewicht nach Bepflanzung ▶ **27 kg** 
-  Anzahl der Setzlinge ▶ **12-15 Anzahl der Setzlinge**

 Gewicht hängt von der Art und der Feuchtigkeit des Bodens ab

VORDERANSICHT

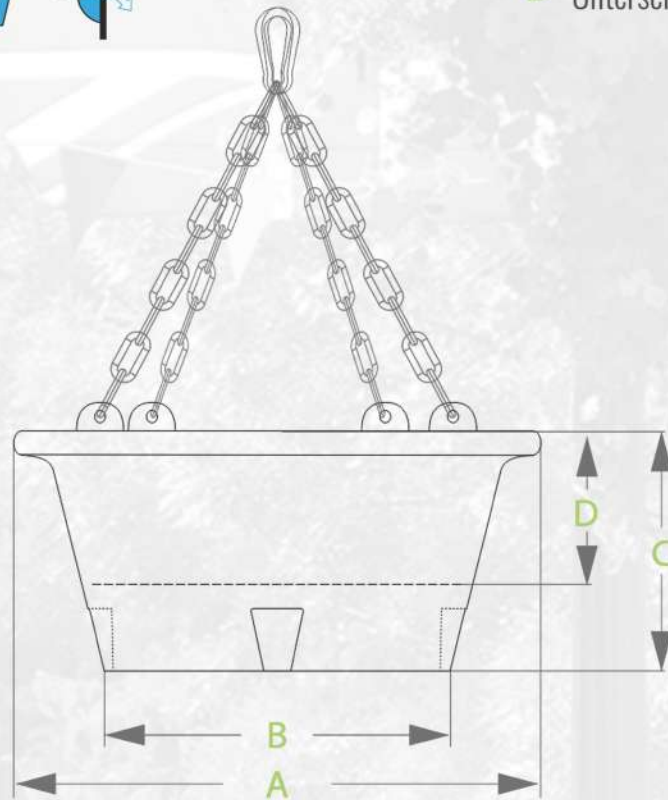

OBENANSICHT

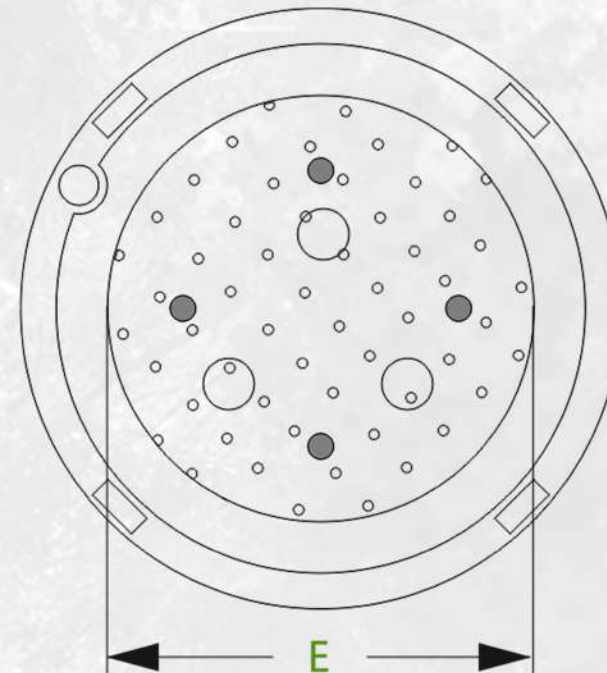



BARIST BASE



MODELL	CODE	DIMENSIONEN[MM]	PREIS
BARIST BASE mit Kette	AB CAS-0P	420mm x 240mm	75 euro
BARIST BASE mit Kette	AB CAS-1P	530mm x 265mm	140 euro

Schwarz



RAL 9005

Dunkelgrün



RAL 6032



10 Jahre Garantie

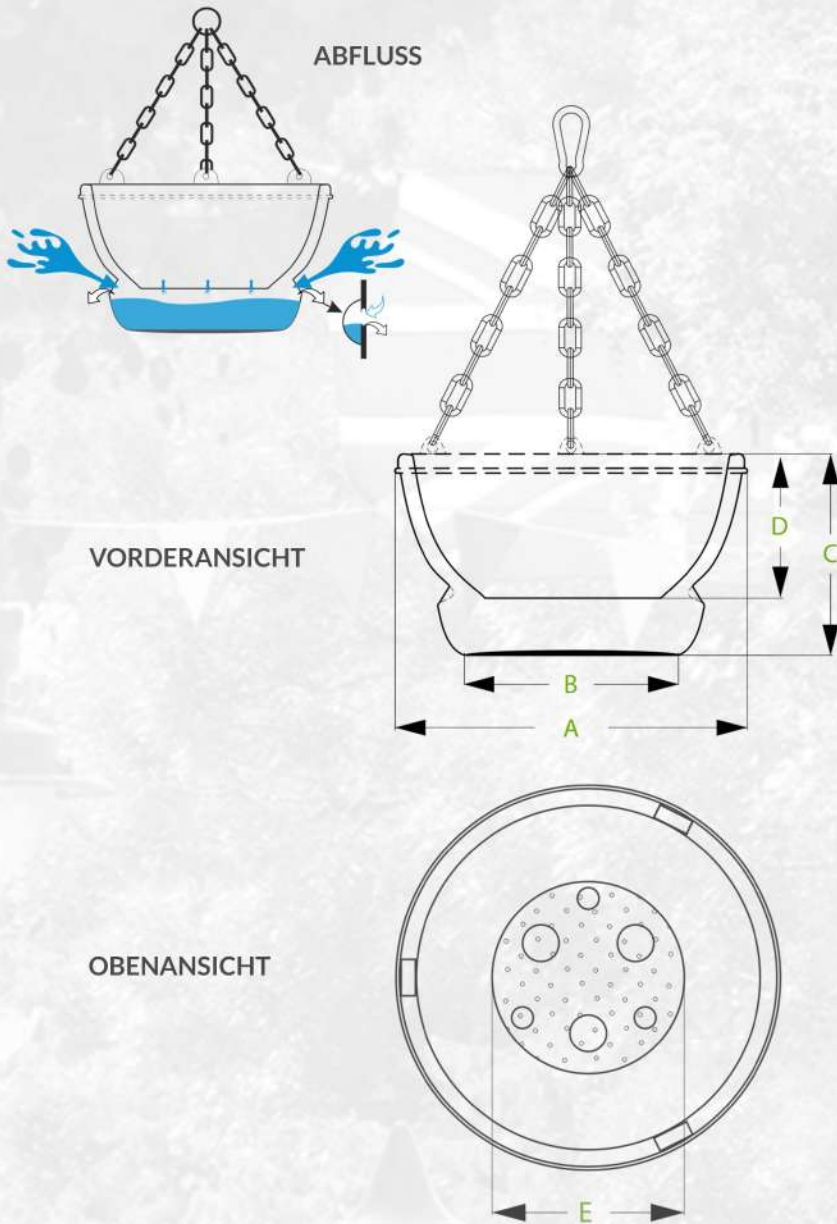

AB CAS-0P

A	Ebenendurchmesser	420 mm
B	Bodendurchmesser	290 mm
C	Gesamthöhe	240 mm
D	Einsatztiefe	150 mm
E	Durchmesser der Unterseite des Einsatzes	210 mm

	Substratvolumen	▶	11 l
	Doppelbodenvolumen	▶	7 l
	Gewicht vor Bepflanzung	▶	2,3 kg
	Gewicht nach Bepflanzung	▶	15 kg
	Anzahl der Setzlinge	▶	8-10 Anzahl der Setzlinge

Gewicht hängt von der Art und der Feuchtigkeit des Bodens ab

AB CAS-1P

A	Ebenendurchmesser	530 mm
B	Bodendurchmesser	320 mm
C	Gesamthöhe	265 mm
D	Einsatztiefe	190 mm
E	Durchmesser der Unterseite des Einsatzes	290 mm

	Substratvolumen	▶	24 l
	Doppelbodenvolumen	▶	13 l
	Gewicht vor Bepflanzung	▶	3,7 kg
	Gewicht nach Bepflanzung	▶	27 kg
	Anzahl der Setzlinge	▶	12-15 Anzahl der Setzlinge

Gewicht hängt von der Art und der Feuchtigkeit des Bodens ab



Garantie 10 Jahre



CESAR



MODELL	CODE	DIMENSIONEN[MM]	PREIS
CESAR mit Kette	AB IMP-0P	500mm x 320mm	135 euro

Schwarz



RAL 9005

Dunkelgrün



RAL 6032

Farbe Sandstein



10 Jahre Garantie

T: +49 30 12 07 46 90 | E: INFO@TERRA-DE.EU | TERRA-DE.EU

 **TerraFlor**

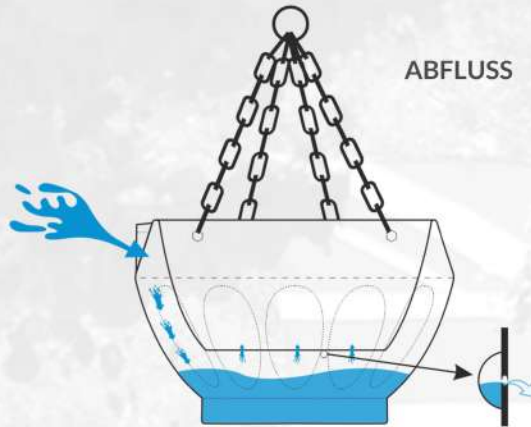

VORDERANSICHT

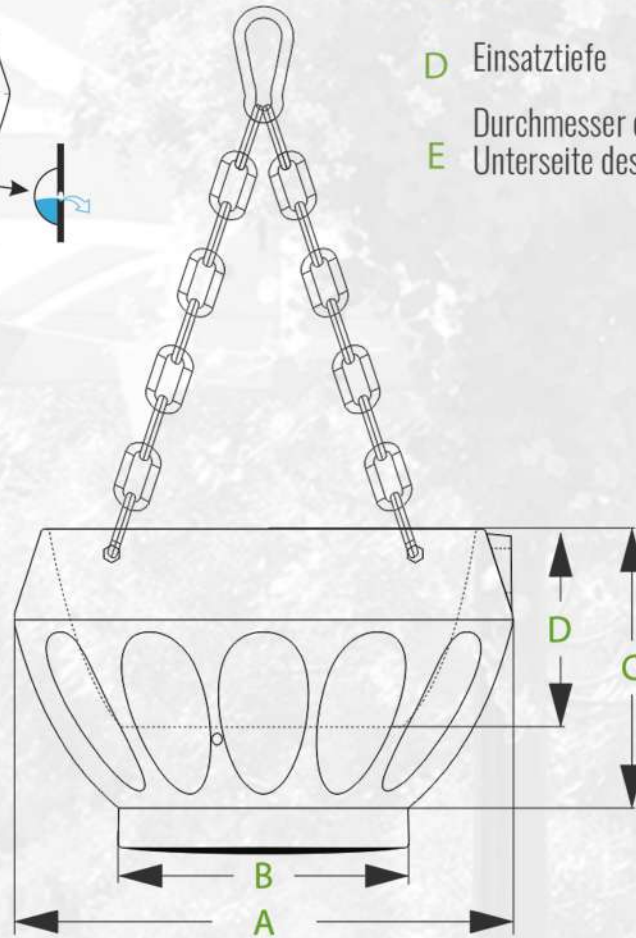

- A** Ebenendurchmesser **500 mm**
- B** Bodendurchmesser **290 mm**
- C** Gesamthöhe **320 mm**
- D** Einsattiefe **195 mm**
- E** Durchmesser der Unterseite des Einsatzes **290 mm**

-  Substratvolumen ▶ **20 l**
-  Doppelbodenvolumen ▶ **8 l**
-  Gewicht vor Bepflanzung ▶ **4,8 kg**
-  Gewicht nach Bepflanzung ▶ **22 kg** 
-  Anzahl der Setzlinge ▶ **10-12 Anzahl der Setzlinge**

 Gewicht hängt von der Art und der Feuchtigkeit des Bodens ab

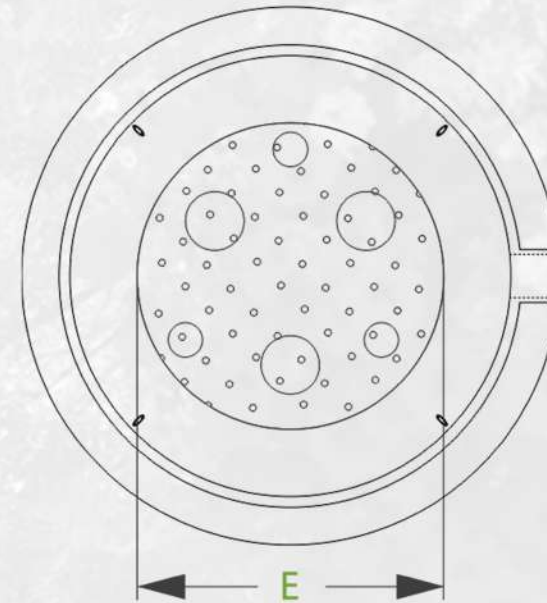

OBENANSICHT



WOVEN

MODELL

CODE

DIMENSIONEN[MM]

PREIS

WOVEN
mit Kette

AB WKR-0P

440mm x 280mm

80 euro

Schwarz

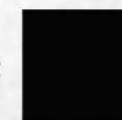

RAL 9005

Dunkelgrün



RAL 6032



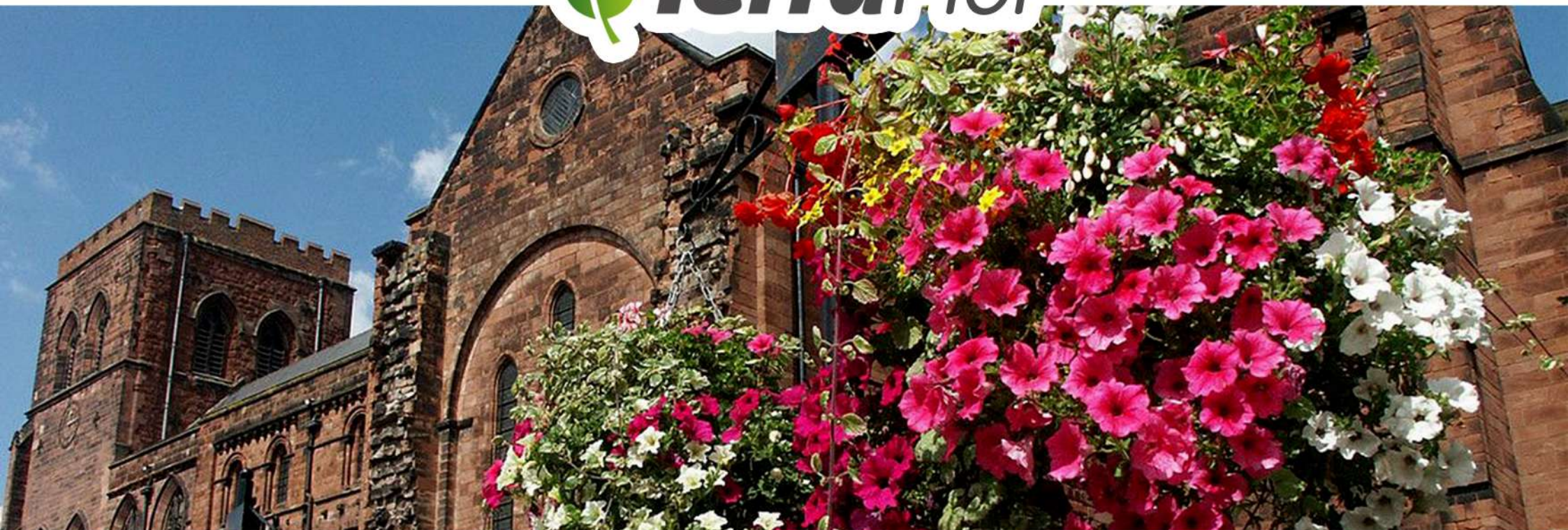

Terra Group

*Gemeinsam sorgen wir für eine
noch schönere Zukunft!*

Mahlsdorfer Straße 61B
15366 Hoppegarten
bei Berlin

T. +49 (0) 30.12 07 46 90
F. +49 (0) 30.12 07 46 909
E: info@terra-de.eu

www.terra-de.eu